

Rocker Switches

Miniature Rocker & Paddle Switches

RK13 Series

UL version available by request

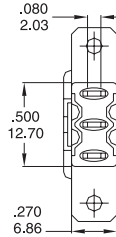
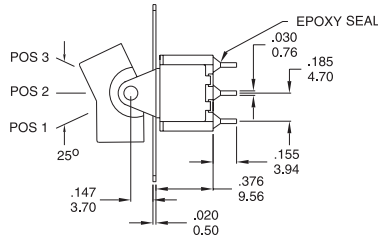
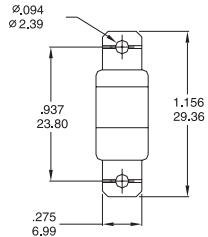

RK1351A1NANT1AGEV

UL version available by request

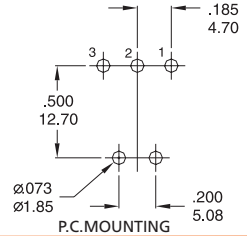
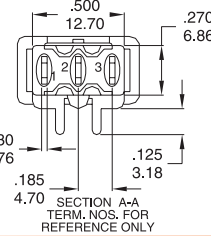
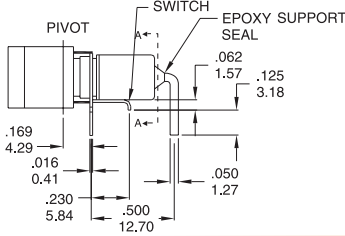
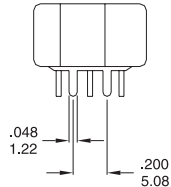

RK1351J1NANT6AGEV

UL version available by request

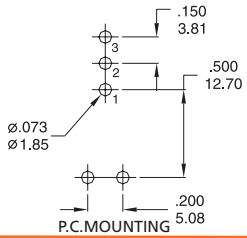
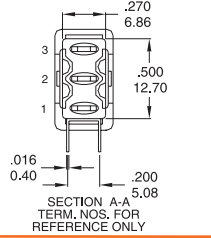
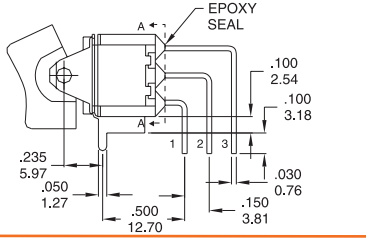
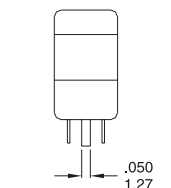

RK1351J1NANT7AGEV

UL version available by request

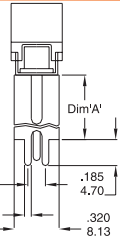
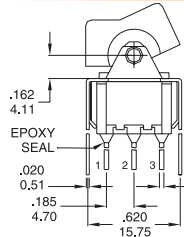

OPTION CODE	DIM. 'A'
VS2	.460 11.68
VS3	.630 16.00

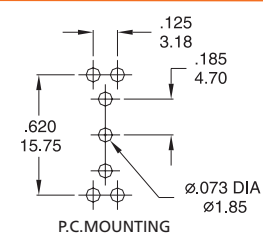

RK1351J1NANVS2AGEV

UL version available by request

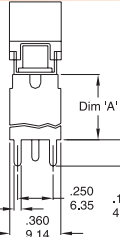
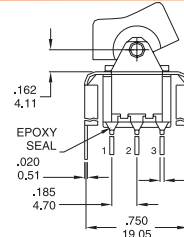

OPTION CODE	DIM. 'A'
VS4	.460 11.68
VS5	.630 16.00

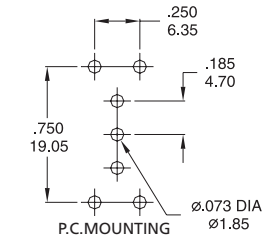

RK1351J1NANVS4AGEV

How to order:

RK13

- 1 POLES & SWITCH FUNCTION:**
- S1 SP ON-NONE-ON
 - S2 SP ON-NONE-MOM
 - S3 SP ON-OFF-ON
 - S4 SP MOM-OFF-MOM
 - S5 SP ON-OFF-MOM
 - D1 DP ON-NONE-ON
 - D2 DP ON-NONE-MOM
 - D3 DP ON-OFF-ON
 - D4 DP MOM-OFF-MOM
 - D5 DP ON-OFF-MOM
 - D6 DP ON-ON-ON
 - D7 DP MOM-ON-MOM
 - D8 DP ON-ON-MOM
 - T1 3P ON-NONE-ON
 - T2 3P ON-NONE-MOM
 - T3 3P ON-OFF-ON
 - T4 3P MOM-OFF-MOM
 - T5 3P ON-OFF-MOM
 - F1 4P ON-NONE-ON
 - F2 4P ON-NONE-MOM
 - F3 4P ON-OFF-ON
 - F4 4P MOM-OFF-MOM
 - F5 4P ON-OFF-MOM
 - F6 4P ON-ON-ON
 - F7 4P MOM-ON-MOM
 - F8 4P ON-ON-MOM
- 2 ACTUATOR:**
- A1 13.49 Long Rocker (Support)
 - A2 Lever (Support)
 - A3 23.01 Long Rocker (Support)
 - A4 Lever (Support)

- A5 33.08 Long Rocker (Support)**
- A6 Rocker with Frame**
- A6K Rocker with Frame, Snap-in**
- A7 Lever with Frame**
- A7K Lever with Frame, Snap-in**
- A8 Lever with Frame**
- A9 Lever with Frame**
- A11 9.19 Long Rocker (Support)**
- A12 Lever (Support)**
- A13 Lever (Support)**
- A16 Lever (Support)**
- A17X Rocker with Frame for LED, Snap-in**
- A18X Lever with Frame for LED, Snap-in**
- 3 ACTUATOR MARKING**
- | | | | | | |
|---|--|---|--|---|--|
| A | | D | | G | |
| B | | E | | H | |
| C | | F | | N | |
- 4 + 5 ACTUATOR & FRAME COLOR**
- | | | | |
|----------------|-----------|---------|---------|
| A Black (Std.) | H Grey | B White | F Green |
| E Yellow | D Orange | C Red | K Brown |
| G Blue | N Without | | |

- 6 TERMINALS:**
- T1 Solder Lug
 - T2 PC Thru-hole
 - T3 Quick Connect
 - T51 18.70 High, Wire Wrap
 - T52 24.20 High, Wire Wrap
 - T53 10.50 High, Wire Wrap
 - T54 26.97 High, Wire Wrap
 - T6 Right Angle, PC Thru-hole
 - T6N Right Angle, Snap-in PC Thru-hole
 - T7 Vertical Right Angle, PC Thru-hole
 - T7N Vertical Right Angle, Snap-in, PC Thru-hole
 - VS2 11.68 High, V-bracket
 - VS3 11.68 High, Snap-in, V-bracket
 - VS4 11.68 High, V-bracket
 - VS5 16.00 High, V-bracket
- 7 CONTACT MATERIAL:**
- AG Silver
 - AU Gold
 - GT Gold, Tin-lead
 - UT Silver, Tin-lead
 - UG Gold over Silver
 - UGT Gold over Silver, Tin-lead
- 8 SEAL:**
- E Epoxy (Standard)
 - N No Epoxy
- 9 ROHS & LEAD FREE:**
- V RoHS compliant
 - blank V RoHS & lead free

General Specifications:

MATERIALS

- » Movable Contact & Fixed Terminals: AG, GT, UG & UGT: Silver plated over copper alloy
AU & UT: Gold over nickel plated over copper alloy
- » Actuator: Nylon
- » Bushing: Brass, nickel plated
- » Housing: Stainless Steel
- » Switch Support: Brass, tin plated

MECHANICAL

- » Operating Temperature: -30°C to +85°C
- » Mechanical Life: 40,000 cycles

CONTACT RATING

- » AG, GT, UG & UGT: 5A 120VAC/28VDC
2A 250VAC
- » AU & UT: 0.4 VA max. 20V max. (AC/DC)

ELECTRICAL

- » Contact Resistance: 10m Ω max. initial @ 2-4VDC for both silver & gold plated contacts
- » Insulation Resistance: 1,000M Ω min
- » Dielectric Strength: 1,000V RMS@sea level

Rocker Switches

Miniature Rocker & Paddle Switches

RK13 Series

UL version available by request

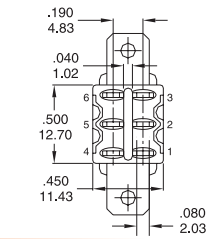
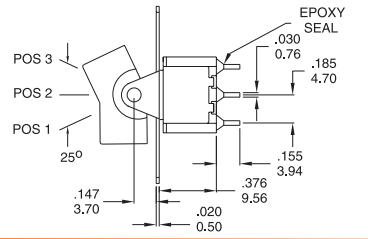
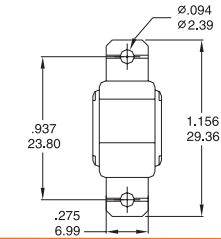

RK13D1A1NANT1AGEV

UL version available by request

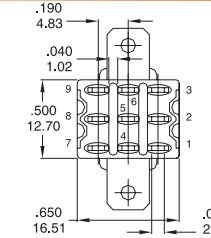
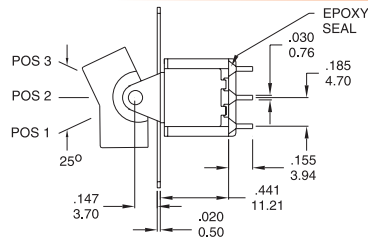
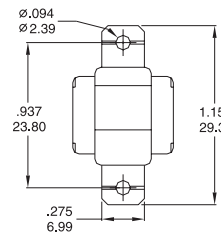

RK13T1A1NANT1AGEV

UL version available by request

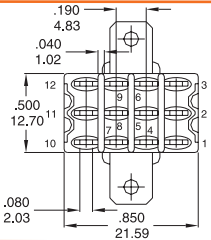
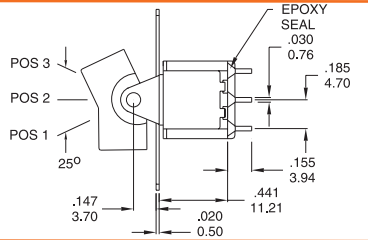
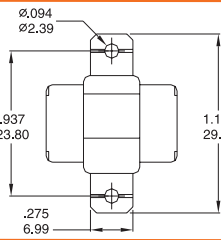

RK13F1A1NANT1AGEV

UL version available by request

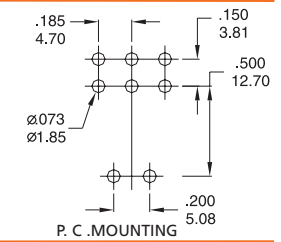
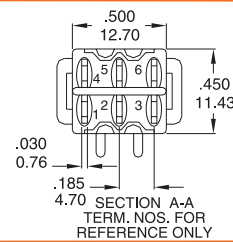
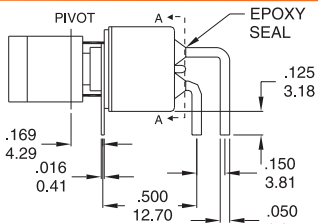
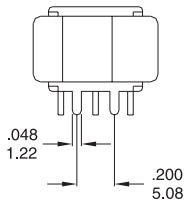

RK13D1J1NANT6AGEV

UL version available by request

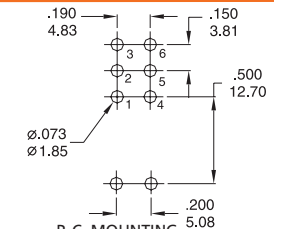
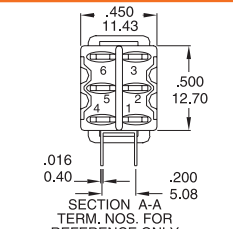
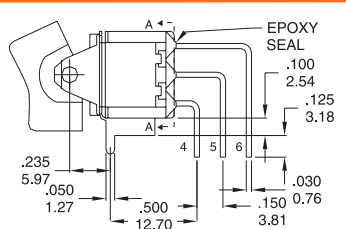
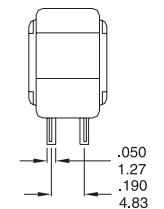

RK13D1J1NANT7AGEV

UL version available by request

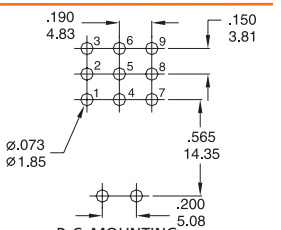
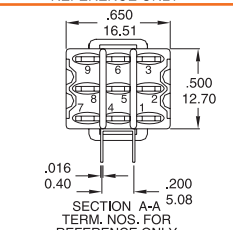
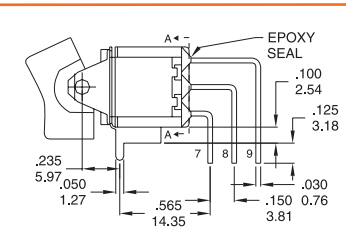
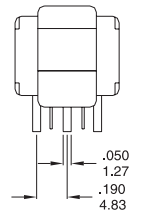

RK13T1J1NANT7AGEV

UL version available by request

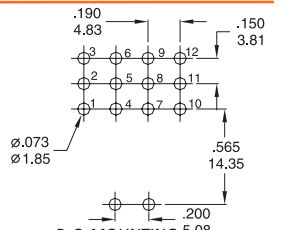
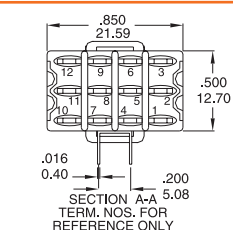
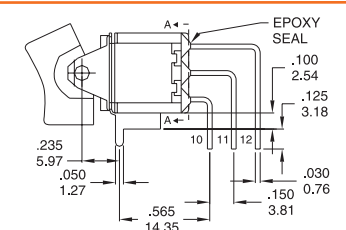
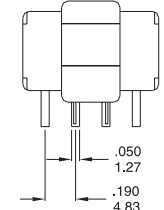

RK13F1J1NANT7AGEV

UL version available by request

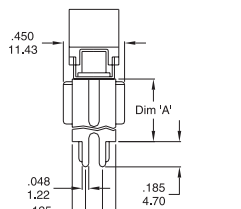
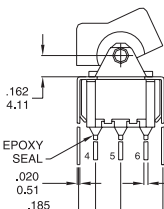

OPTION CODE	DIM. 'A'
VS2	.460 11.68
VS3	.630 16.00

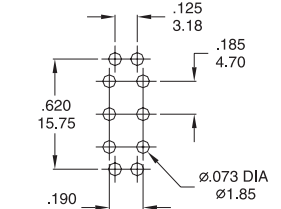

RK13D1J1NANVS2AGEV

Rocker Switches

Miniature Rocker & Paddle Switches

RK13 Series

UL version available by request



RK13D1J1NANV5SAGEV

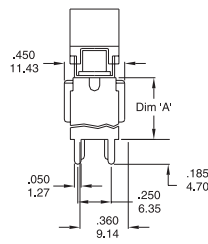
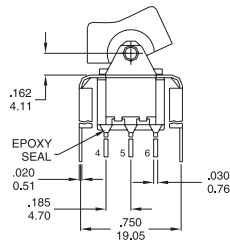

OPTION CODE	DIM. 'A'
VS4	.460 11.68
VS5	.630 16.00

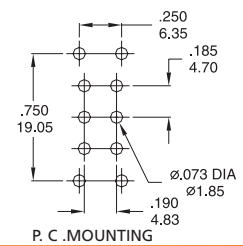

SWITCH FUNCTION

NO. POLES	MODEL NO.	SWITCH FUNCTION			CONNECTED TERMINALS / SCHEMATIC		
		POS.1	POS.2	POS.3	POS.1	POS.2	POS.3
SP	S1	ON	NONE	ON		N/A	
	S2	ON	NONE	MOM			
	S3	ON	OFF	ON			
	S4	MOM	OFF	MOM			
	S5	ON	OFF	MOM			
DP ▲ ▲	D1	ON	NONE	ON		N/A	
	D2	ON	NONE	MOM			
	D3	ON	OFF	ON			
	D4	MOM	OFF	MOM			
	D5	ON	OFF	MOM			
	D6	ON	ON	ON			
	D7	MOM	ON	MOM			
	D8	ON	ON	MOM			
3P	T1	ON	NONE	ON		N/A	
	T2	ON	NONE	MOM			
	T3	ON	OFF	ON			
	T4	MOM	OFF	MOM			
	T5	ON	OFF	MOM			
4P ▲ ▲	F1	ON	NONE	ON		N/A	
	F2	ON	NONE	MOM			
	F3	ON	OFF	ON			
	F4	MOM	OFF	MOM			
	F5	ON	OFF	MOM			
	F6	ON	ON	ON			
	F7	MOM	ON	MOM			
	F8	ON	ON	MOM			

MOM=MOMENTARY

▲ Please check the availability in advance before order

Rocker Switches

Miniature Rocker & Paddle Switches

RK13 Series

ACTUATOR OPTIONS FOR PANEL MOUNT ONLY

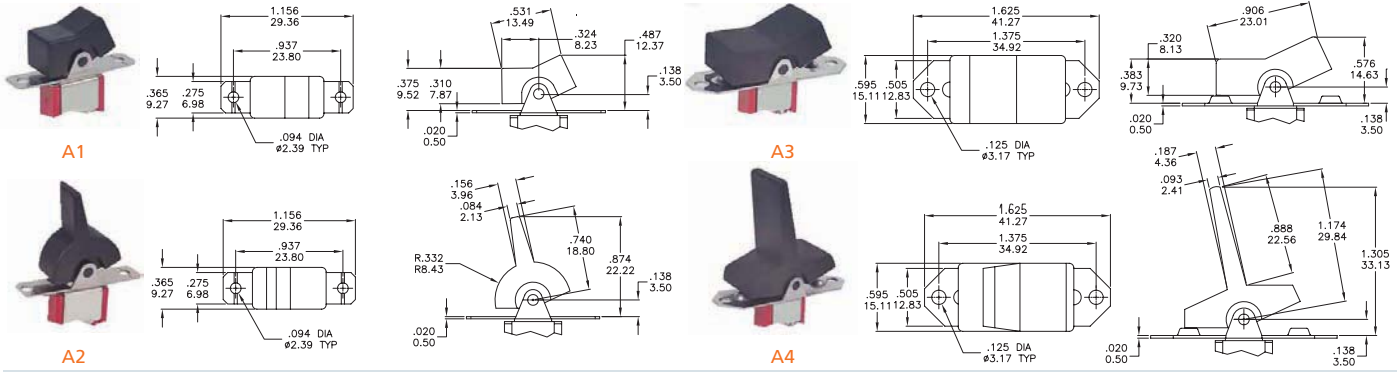

ACTUATOR OPTIONS SNAP-IN FRONT MOUNT

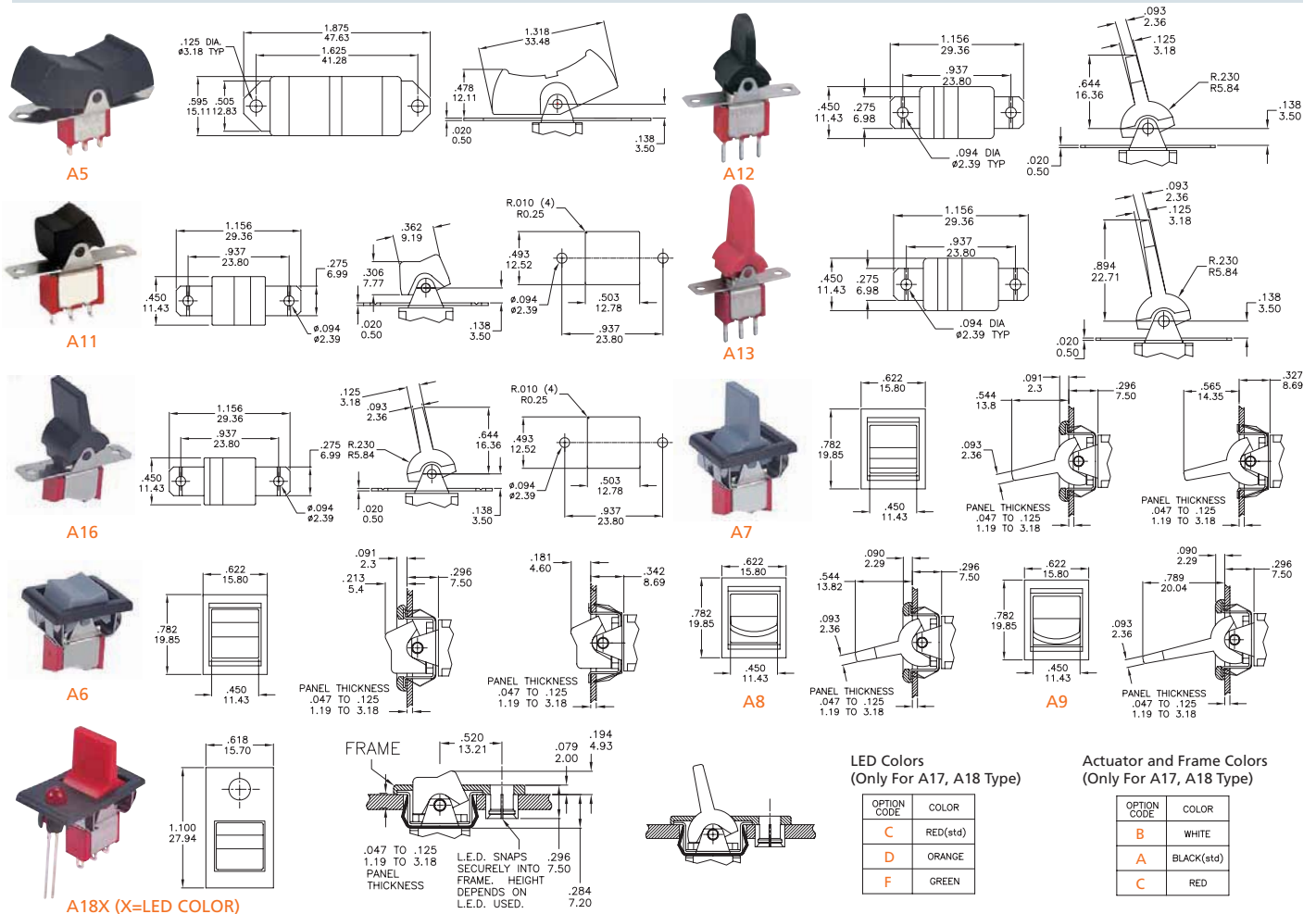

LED Colors (Only For A17, A18 Type)

OPTION CODE	COLOR
C	RED(std)
D	ORANGE
F	GREEN

Actuator and Frame Colors (Only For A17, A18 Type)

OPTION CODE	COLOR
B	WHITE
A	BLACK(std)
C	RED

RECOMMENDED MOUNTING

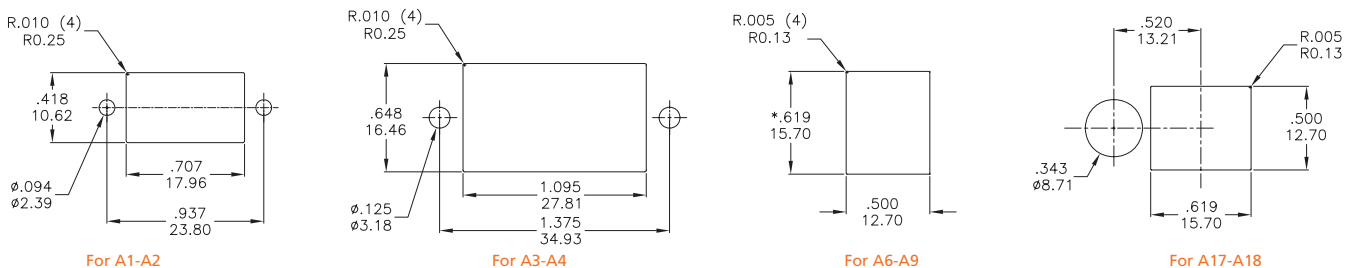

*For A8 and A9: Increase this dim. to .620/.625(15,75/15,88) for .091/.125 (2,31/3,18) thk. panels.

* For A6 and A7: Increase this dim. to .620/.625(15,75/15,88) for .060/.125 (1,52/3,18) thk. panels.

Rocker Switches

Miniature Rocker & Paddle Switches

RK13 Series

ACTUATOR OPTIONS FOR P. C. MOUNT ONLY

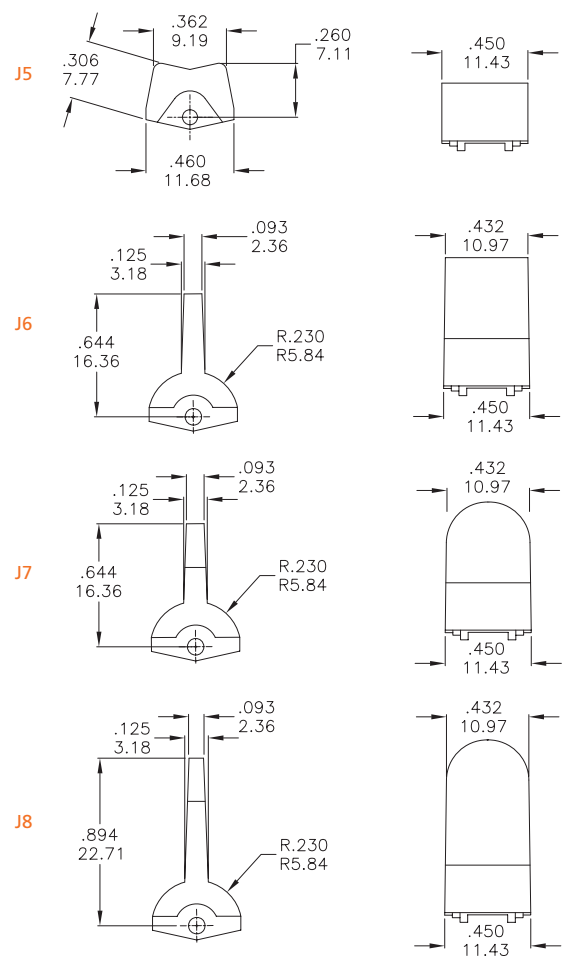
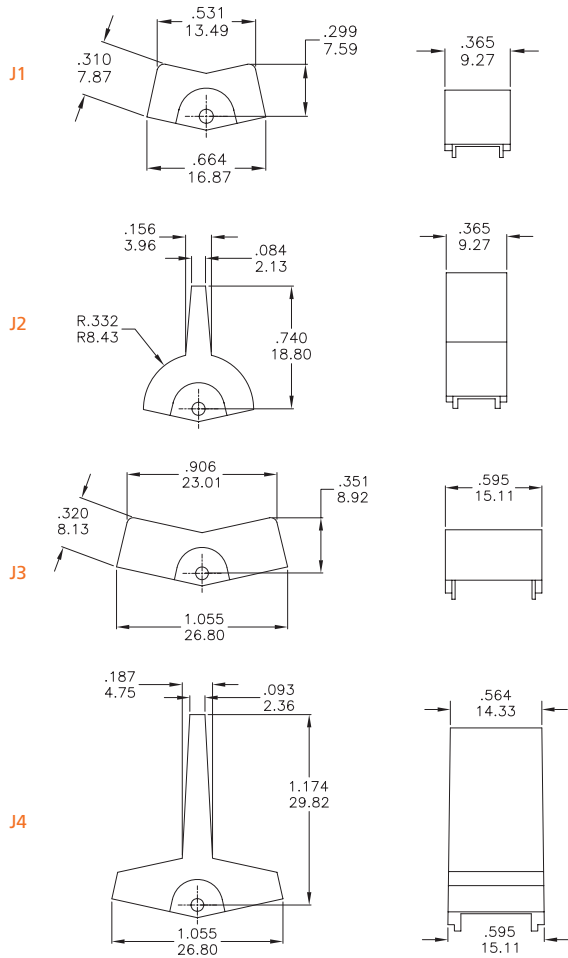

TERMINATION OPTIONS

T1 SOLDER LUG

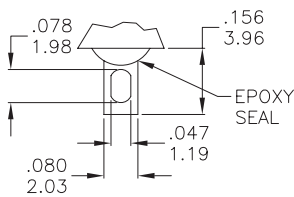

THK .030(0.76)

T2 PC THRU - HOLE

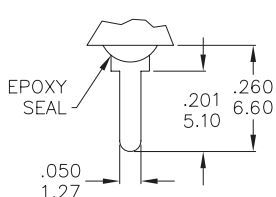

THK .030(0.76)

T3 QUICK CONNECT

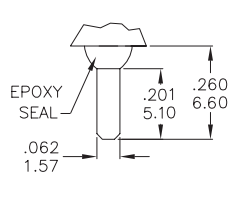

THK .030(0.76)

T5 WIRE WRAP

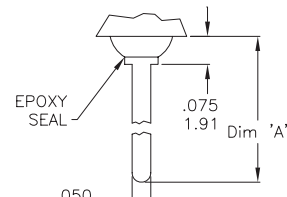

THK .030(0.76)

OPTION CODE	DIM. 'A'
T51	.737(18.70)
T52	.953(24.20)
T53	.415(10.55)
T54	1.062(26.97)

SNAP - IN TERMINATION OPTIONS

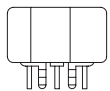

T6N

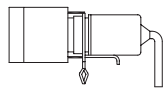

V2N

