

# Multi-Direction Switches

## SMT Double Action Switch

## MB6 Series

Unit: mm [inch]  
General Tolerance: ± 0.2 mm

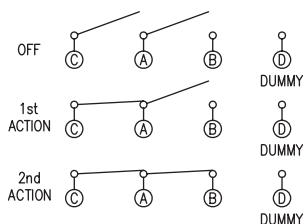
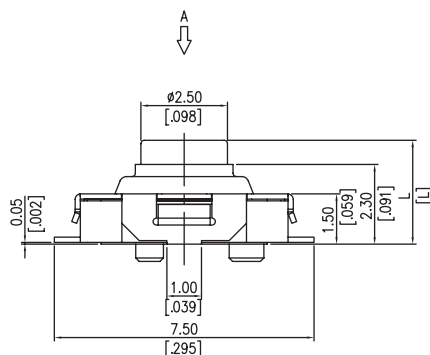
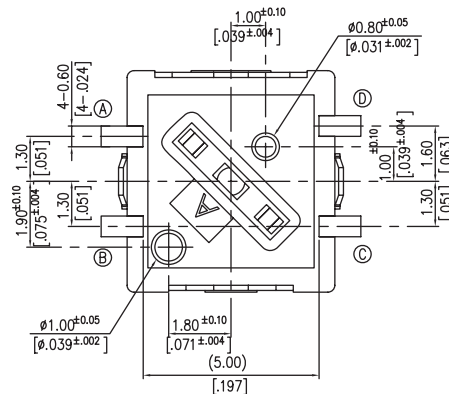
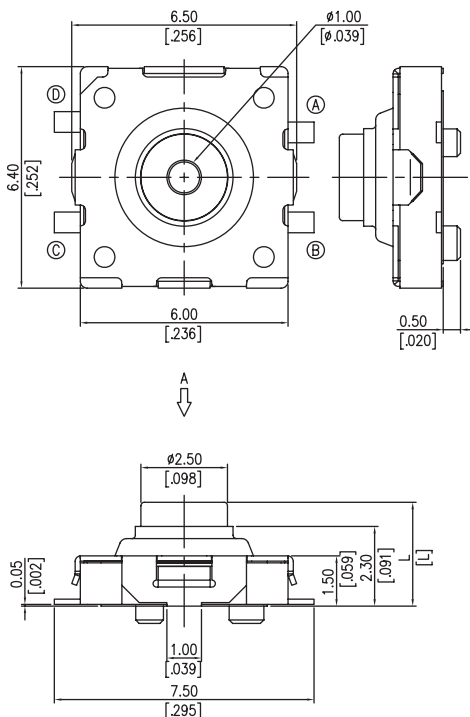
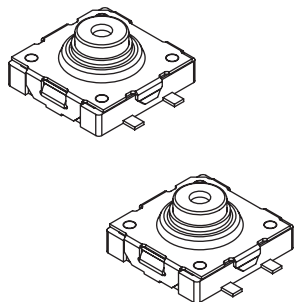

Circuit

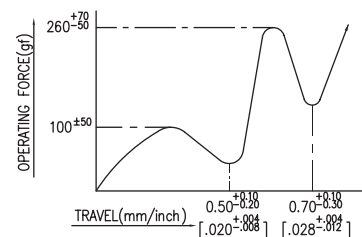

Operating Force - Travel Chart

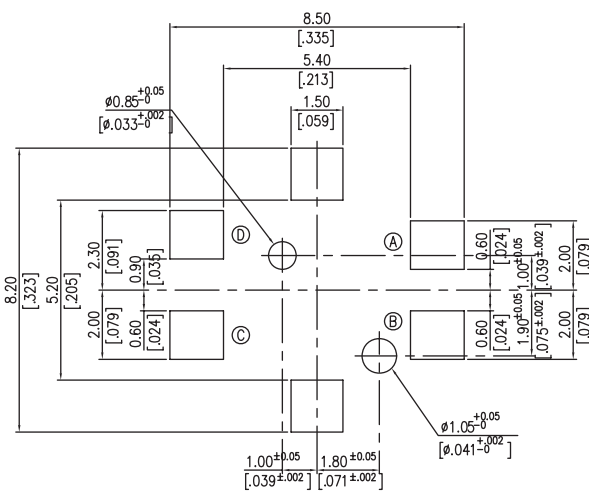

P.C.B. LAYOUT (View from the Direction A)

### How to order:

**MB6**

**1** HEIGHT "L" (see drawings):

**30** L = 3.00 mm [.118 inch]

**38** L = 3.80 mm [.150 inch]

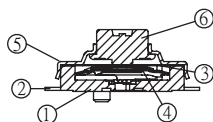

Item	Object	Qty	Materials	Treatment
1	Base	1	Nylon UL 94V-0	Black
2	Terminals	1	Copper Alloy	Silver Plating
3	Dustcover	1	PTFE	White
4	Contact Disc	2	Stainless Steel	Silver Cladding
5	Cover	1	Nickel Silver	
6	Stem	1	Nylon UL 94V-0	Black

All products of GREATECS are RoHS compliant.

### SPECIFICATIONS

#### 1. Style

This specification describes "DOUBLE ACTION SWITCH", mainly used as signal switch of electric devices, with the general requirements of mechanical and electrical characteristic.

1.1 Operating Temperature Range : -20 °C ~ +70 °C

1.2 Storage Temperature Range : -30 °C ~ +85 °C

#### 2. Current Range: 50mA, 12V DC

#### 3. Type of Actuation: Double Action Tactile Feedback

#### 4. Test Sequence:

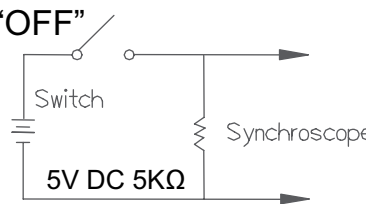
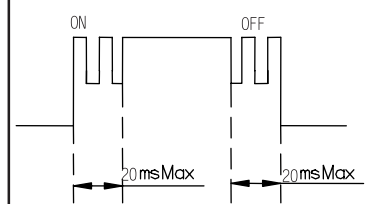
	ITEM	DESCRIPTION	TEST CONDITIONS	REQUIREMENTS
APPEARANCE	1	Visual Examination	By visual examination check without any out pressure & testing	There shall be no defects that affect the serviceability of the product.
ELECTRIC PERFORMANCE	2	Contact Resistance	Applying a static load twice the actuating fore to actuator. Measurements shall be made with a 1 kHz small current contact resistance meter.(20mV 50mA max)	100mΩ Max
	3	Insulation Resistance	Measurements shall be made following application of 100 V DC potential across terminals and across terminals and frame.	100MΩ Min
	4	Dielectric Withstanding Voltage	250 V AC(50Hz or 60Hz) shall be applied across terminals and across terminals and frame for 1 minute.	There shall be no breakdown or flashover
	5	Bounce	Lightly striking the actuator at a rate encountered 3 to 4 operations per sec, bounce shall be tested at "ON" and "OFF" 	20 m seconds Max. 

# Multi-Direction Switches

SMT Double Action Switch

MB6 Series

MECHANICAL PERFORMANCE	6	Operating Force & Stroke	Refer to part on drawing	-
	7	Stop Strength	Placing the switch such that the direction of switch operation is vertical, a static load of 3 kgf (29.4N) shall be applied in the direction of stem operation for a period of 15 seconds	1 Contact Resistance: 10Ω Max 2 Insulation Resistance: 10MΩ Min 3 Bounce: 20 m seconds max 4 Voltage: AC 250V 1minute Min
	8	Solder Heat Resistance	■ SMT Type~MB6 Series	1 Shall be free from pronounced backlash and falling-off or breakage terminals 2 Contact Resistance: 10Ω Max 3 Insulation Resistance: 10MΩ Min 4 Bounce: 20 m seconds max 5 Voltage: AC 250V 1minute Min
	9	Vibration	Shall be vibrated in accordance with Method 201A of MIL-STD-202F Range of oscillation: 10 to 55 Hz 1) Swing distance = 1.5mm 2) Frequency: 10-55-10Hz in 1-min/cycle. 3) Direction of oscillation: Three mutually perpendicular directions, including the directions of stem travel. 4) Test time: 2 hours each direction	1 Contact Resistance: 10Ω Max 2 Insulation Resistance: 10MΩ Min 3 Bounce: 20 m seconds max 4 Voltage: AC 250V 1minute Min
	10	Shock	Shall be shocked in accordance with Method 213B condition A of MIL-STD-202F 1) Acceleration; 50G 2) Action time: 11±1m seconds 3) Testing Direction: 6 sides 4) Test Cycle: 3 times in each direction	Ditto

# Multi-Direction Switches

SMT Double Action Switch

MB6 Series

<b>DURABILITY</b>	11	Operating Life	<p>Measurements shall be made following the test set forth below :</p> <p>1 5mA,5 VDC resistive load 2 Applying a static load the operating force to the center of the stem in the direction of operation Static Load = OF Max. 3 Cycle of Operation : 30,000 cycles Min</p>	<p>1 Operating force:±30% of initial force 2 Contact Resistance: 10Ω Max 3 Insulation Resistance: 10MΩ Min 4 Bounce: 20 m seconds max 5 Voltage: AC 250V 1minute Min</p>	
	<b>WEATHER-PROOF</b>	12	Resistance Low Temperature	<p>Following the test set forth below the sample shall be left in normal temperature and humidity conditions for 1 hour before the measurements are made:</p> <p>1 Temperature:-30±2°C 2 Time: 96 hours</p>	<p>1 Contact Resistance: 10Ω Max 2 Insulation Resistance: 10MΩ Min 3 Bounce: 20 m seconds max 4 Voltage: AC 250V 1minute Min</p>
		13	Heat Resistance	<p>Following the test set forth below the sample shall be left in normal temperature and humidity conditions for 1 hour before the measurements are made:</p> <p>1 Temperature:85±2°C 2 Time: 96 hours</p>	Ditto
14		Humidity Resistance	<p>Following the test set forth below the sample shall be left in normal temperature and humidity conditions for 1 hour before the measurements are made:</p> <p>1 Temperature:40±2°C 2 Relative Humidity: 90~95% 3 Time: 96 hours</p>	Ditto	

## 5. SOLDERING CONDITIONS:

### ■ Reflow Soldering

### ■ Manual Soldering

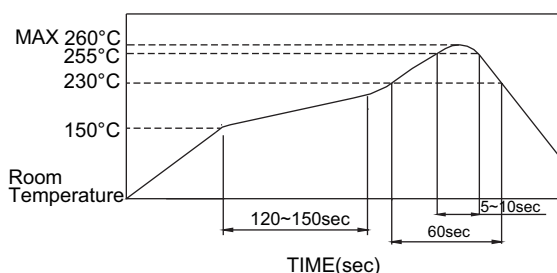

Soldering Temperature	Max. 350 °C
Continuous Soldering Time	Max. 5 seconds